



Changelite Lighting

LED Emergency Bulkhead



FEATURES

- 3 hour maintained or non-maintained
- Complete with 2.5W LED strip
- Zero maintenance with led lifespan of 30,000 hours(L70)
- Robust Polycarbonate Body and Diffuser
- 25 metre viewing distance(when used with exit legend)
- Manufactured to BS 60598-2-22

Mounting type:

- Wall Interior Option Red Diffuser
 Ceiling Exterior Option Opal Diffuser



STANDARDS

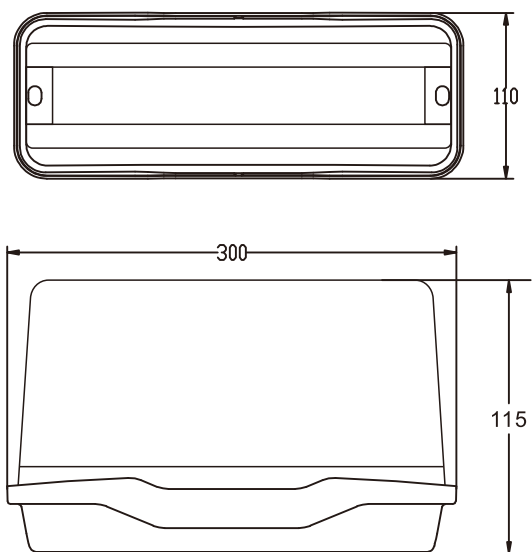
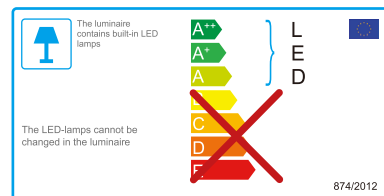

Technical Specifications

Part Code	CL02EM
Input Voltage	100-240V 50Hz
Wattage	2.5W
Lumens	250lm
Emergency Lumens	250lm
Battery pack	Lithium battery 6.4V 2200mAh
Charge time	24 hours
Discharge time	3 hours
Class	ClassII
Type	Maintained and non-maintained
Lifespan(LM80)	30,000 hours
Operating Temp	0°C to +50°C
Self test	NO
Housing Material	Polycarbonate